

Standard Preparation Cupboard with 1 Hinged Door - no top, 500mm

ITEM # _____

MODEL # _____

NAME # _____

SIS # _____

AIA # _____

133174 (RAU5001HD)

 Cupboard with 1 hinged
door - no Top, 500mm

Short Form Specification

Item No. _____

Made entirely from stainless steel. Inner welded frame in stainless steel.
 No top unit for integrated solutions. Base panel in 304 AISI stainless steel
 and height-adjustable intermediate shelf. Sound-deadened hinged door.
 Mounted on feet, adjustable in height.

Main Features

- Ideal for central positioning in the kitchen, either as island installation or back to back.
- Handles in stainless steel for better hygiene and reliability.
- Sturdiness, stability and reliability of table accurately tested.

Construction

- Reinforced side and base panel in 304 AISI stainless steel.
- 304 AISI stainless steel feet, 200 mm high and 54 mm in diameter, adjustable by -50/+30 mm.
- Inner welded frame in stainless steel to guarantee superior strength and stability.
- Equipped with intermediate shelf which can be positioned at three different heights.
- Sturdy sound-deadened hinged doors on tracks located flush to the front of the frame.
- Hinged door with sound deadening internal panels, fitted with 304 AISI stainless steel hinges on the inner sides.
- Without top for integrated solutions.

Optional Accessories

- Stainless steel front kicking strip PNC 133205
- Side kicking strip, 700 mm PNC 133206

APPROVAL: _____

Front

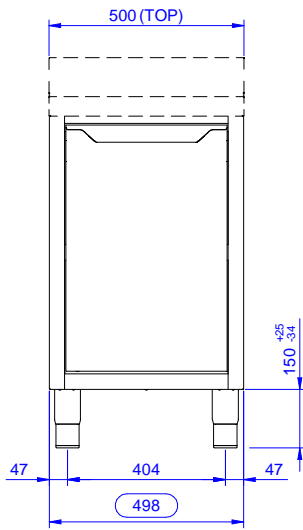

Side

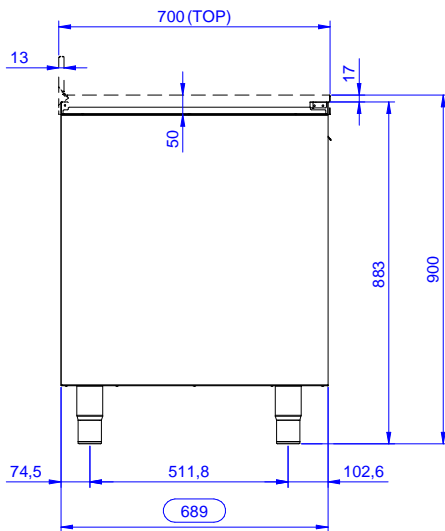

Top

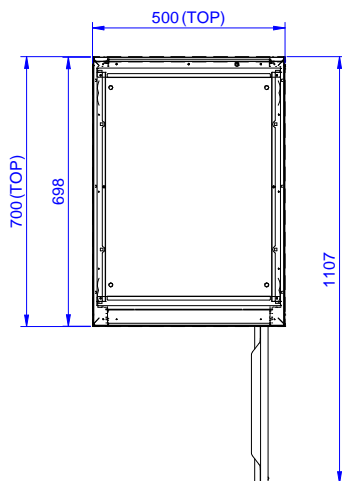
Key Information:

Cabinet width:		
133174 (RAU5001HD)	445 mm	
Cabinet depth:	645 mm	
Cabinet height:	610 mm	
External dimensions, Width:	500 mm	
External dimensions, Depth:	700 mm	
External dimensions, Height:	883 mm	
Number and type of doors:	1 Hinged	
Net weight:	28 kg	